

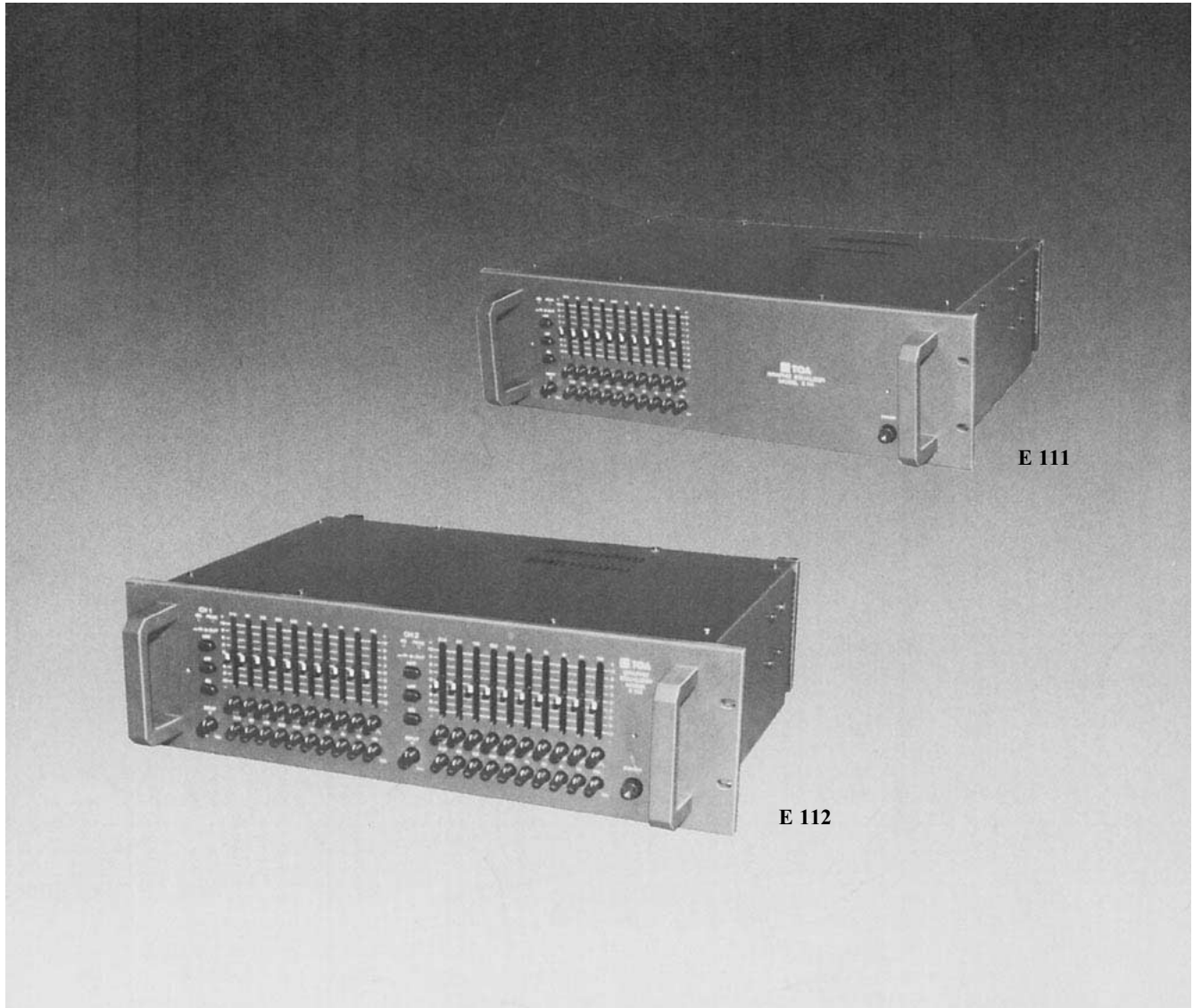

TOA PROFESSIONAL GRAPHIC EQUALIZER

Model E 111, E 112



TOA ELECTRIC CO., LTD.
KOBE, JAPAN

Contents

Precautions	1
General Description	2
Features	2
Specifications	3
Appearance	3
Performance Graphs	4
Front Panel	5
Rear Panel	6
Input/Output Connections	7
Installation Precautions	7~8
Functions	8
Applications	9~10

Precautions

1. XLR type audio connectors are wired as follows.
Pin 1 is ground (shield), pin 2 is cold (low, minus), and pin 3 is hot (high, plus).
2. Each model of the E 111 and E 112 has two versions, 120V AC operation only and 220/240V AC operation with a voltage selector. The voltage selector on the rear panel of the 220/240V version should be checked for proper setting prior to operation as improper setting causes trouble. The voltage selector is set for 240V operation at the factory.
3. Do not operate the equalizer from power mains which exceeds the indicated mains voltage by more than 10%.
4. Do not expose the equalizer to corrosive chemicals or liquids such as soft drinks, salt water, etc.
5. Always refer the equalizer to qualified technical service personnel. There are no user serviceable parts inside.

General Description

The TOA E 111 is a single channel, 1/1 octave active graphic equalizer designed to allow clean, accurate audio equalization for stage, studio, or commercial applications, while the E 112 is a double channel version.

The E 111 and E 112 provide 12dB of boost or cut at each of its 10 frequencies per channel, which are centered at ISO 1/1 octave increments from 31.5Hz to 16kHz. The center frequency of each filter is continuously variable over a range of one octave and the "Q" of each filter is continuously variable from 1.5 to 8. Its signal to noise ratio is over 120dB making the E 111 and E 112 one of the quietest equalizers on the market.

The active bandpass/bandreject filters of the E 111 and E 112 are designed for minimum phase shift, and feature smooth slide controls with center detents for easy and accurate adjustment. The filters are summed in parallel for reliability, so that the failure of one filter does not interrupt operation of the others.

In addition, high-pass and low-pass filters are provided on the front panel. The high-pass filter has a slope of 12 dB per octave and its cutoff frequency is 40Hz, while the low-pass filter has a 12 dB per octave slope and its cutoff frequency is 12kHz.

An input level control on the E 111 or E 112 gives 12 dB of adjustment to allow a wide variety of input sources. An LED indicator illuminates when either the input or the output comes within 6 dB of clipping. In addition to the usual EQ in/out switch, an automatic EQ bypass function provides complete equalization bypass in the event of loss of AC power, and an output muting function suppresses turn-on/turn-off transients.

A smoked plastic security cover is included with the E 111 or E 112 to guard against accidental disturbance, or intentional tampering when used in fixed installations.

Inputs and outputs are transformer-isolated and balanced, with both XLR and 1/4" stereo phone jacks. Ground lift switches are provided at both inputs and outputs to reduce hum and prevent ground loops.

The E 111 and E 112 can be mounted in a standard 19" rack and occupy 5-1/4" of vertical space. The rugged front panel is made of 1/8" (3mm) cast aluminum, backed with a 1/8" (3mm) steel liner for added durability.

Features

1. 10 filters per channel on ISO 1/1 octave center frequencies from 31.5Hz to 16kHz.
2. 12dB boost or cut at each center frequency, continuously variable.
3. Continuously variable center frequency control at each frequency over a one octave range.
4. Continuously variable "Q" control at each frequency from 1.5 to 8.
5. Signal to noise ratio greater than 120dB.
6. High quality, low phase-shift active filters.
7. Precision calibrated, noiseless slide controls with center detent.
8. Equalizer In/Out switch.
9. High- and low-pass filters.
10. LED peak indicator to detect clipping at input or output levels.
11. Variable input level control to accept variety of input sources.
12. Automatic EQ bypass circuitry.
13. Transformer-isolated balanced inputs and outputs with XLR connectors and phone jacks.
14. Ground lift switches on input and output.
15. Smoked, plastic security cover is included.
16. Heavy aluminum die-cast front panel, standard 19" rack mountable.

Specifications

Frequency Response

±1dB, 20Hz to 20kHz

Total Harmonic Distortion

Less than 0.2% at 1kHz, all sliders at 0 position, rated output

Equalization Center Frequencies

From 31.5Hz to 16kHz

peaking type

31.5Hz (22Hz to 44Hz)

63Hz (44Hz to 88Hz)

125Hz (88Hz to 176Hz)

250Hz (176Hz to 350Hz)

500Hz (350Hz to 700Hz)

1kHz (700Hz to 1.4kHz)

2kHz (1.4kHz to 2.8kHz)

4kHz (2.8kHz to 5.5kHz)

8kHz (5.5kHz to 11kHz)

16kHz (11kHz to 22kHz)

Range of Adjustment of "Q"

1.5 to 8

Equalization Control

±12dB

Input Level Control

±12dB

Rated Input Level

+4dB

Rated Output Level

+4dB

Maximum Input Level

+24dB* at 1kHz

Maximum Output Level

+24dB* with 600-ohm load

Input Impedance

10k ohms

Output Impedance

600 ohms

High Pass Filter

40Hz, 12dB/octave

Low Pass Filter

12kHz, 12dB/octave

Hum and Noise

-103dB* (EQ IN, all sliders at 0 position, A curve by IHF)

Protect

AC fail safe

Power Consumption

E 111: 10W

E 112: 19W

Dimensions

483(W)×133(H)×370(L) mm

19(W)×5.25(H)×14.6(L) inches

Weight

E 111: 7.6kg (17 lbs)

E 112: 8.8kg (19 lbs)

Finish

Black

Indicators

Peak Indicator LED turns on at 6dB before clipping

EQ, Power Indicators Green Color LED

Accessories

AC Cord, Cord Clamp

*0dB is referenced to 0.775 volts RMS.

Appearance

The E 111 is the same in dimension as the E 112.

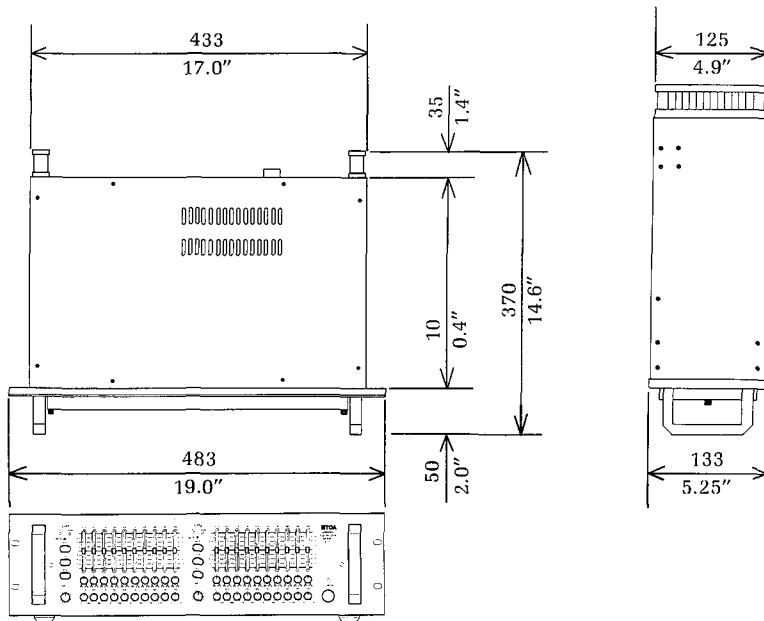

Performance Graphs

FREQUENCY RESPONSE

(Each slider is set at a max position)

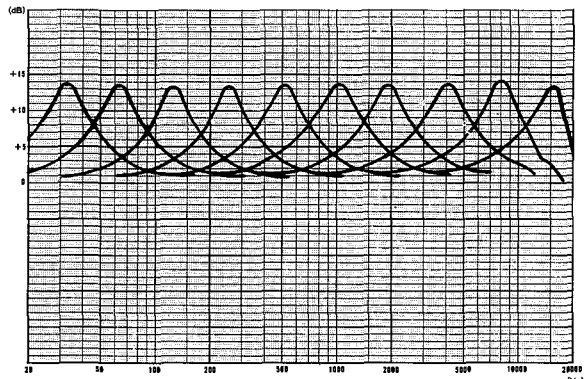

FREQUENCY

FREQUENCY RESPONSE (ex. 1kHz slider)

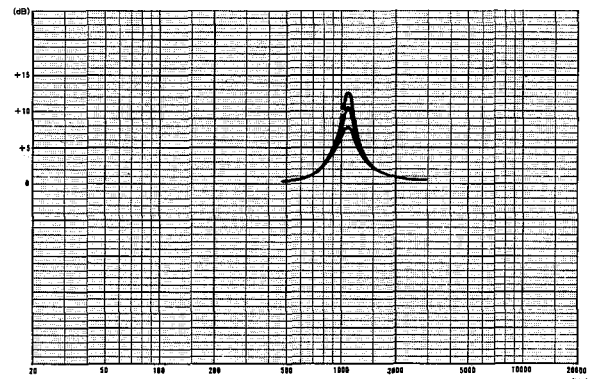

FREQUENCY

BANDWIDTH CONTROL (ex. 1kHz slider)

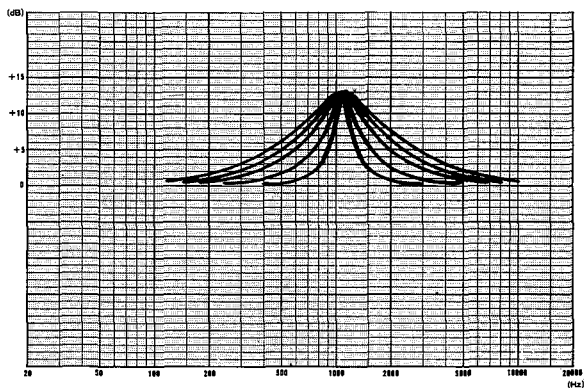

FREQUENCY

CENTER FREQUENCY CONTROL (ex. 1kHz slider)

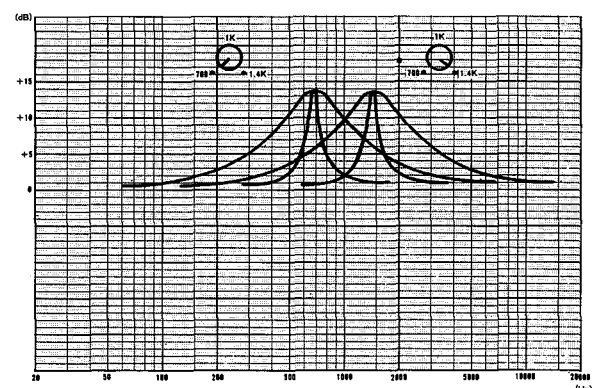

FREQUENCY

Front Panel

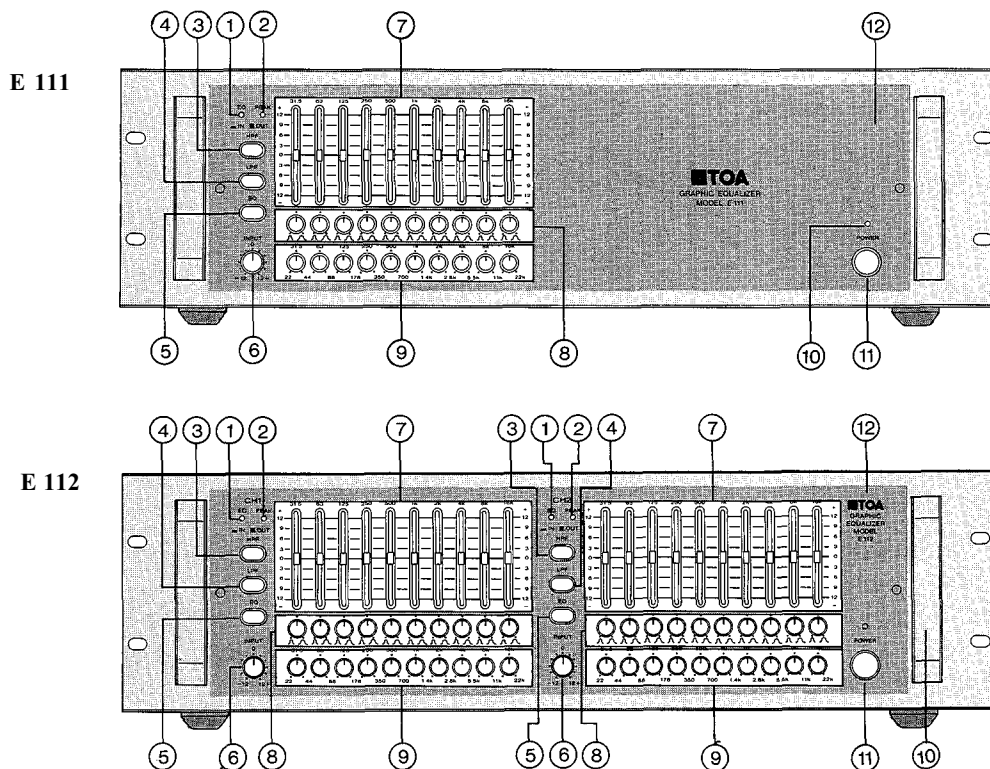

- ① **Equalizer LED indicator**
Allows adjustment of frequency response by using the EQ sliders ⑦ bandwidth controls ⑧ and Centre frequency controls ⑨ while the LED remains lit. The frequency response is flat regardless of the position of the EQ sliders when the LED is extinguished. Select either of the frequency modes with the equalizer switch ⑤.
- ② **Peak LED indicator**
Lights when the output exceeds 6dB before a clipping level is reached. For minimum noise, adjust the input controls ⑥ so the LED can come on occasionally. When the LED still lights up even if the input level control ⑥ is fully turned to "-12", decrease the output level of equipment connected to the rear-mounted input XLR connector or jack ⑰.
- ③ **Highpass filter switch**
Attenuates the frequency component lower than 40Hz at the rate of 12dB per octave in the IN position.
- ④ **Lowpass filter switch**
Attenuates the frequency component higher than 12kHz at the rate of 12dB per octave when IN.
- ⑤ **Equalizer switch**
Placing the switch in the IN position causes the equalizer LED indicator ① to turn on, and provides the frequency response adjusted with the EQ sliders ⑦, bandwidth controls ⑧ and centre frequency controls ⑨. With the switch in the OUT position, the equalizer LED goes out and the frequency response is flat just as the EQ sliders ⑦ allow for a flat response when set to "0".
- ⑥ **Input level control**
Adjusts the input level within range of -12dB to +12dB. Adjusting the control so the peak LED indicator ② may occasionally light up reduces noise generated in the E 111 and E 112 equalizers. When the peak indicator ② still comes on even if the control is fully turned to the "-12" position, decrease the output level of equipment connected to the rear-mounted input XLR connector or jack ⑰.
- ⑦ **EQ sliders**
Provide 12dB of boost or cut at each of the 10 frequencies, which are centred at ISO 1 octave increments from 31.5 to 16 kHz.
- ⑧ **Bandwidth controls**
Adjust a bandwidth. ("Q" is adjustable within range of 1.5 to 8.)
- ⑨ **Centre frequency controls**
Adjust the centre frequency within range of 1 octave.

Front Panel

⑩ Power LED indicator

It is possible to operate the E 111 and E 112 equalizers while the LED remains lit. While the LED is OFF, the signal fed to the rear-mounted input connector or jack ⑰ is delivered to the output connector or jack ⑯ as it is.

⑪ Power switch

Pushing this switch causes the power LED ⑩ to light and puts the equalizer in the operation mode. By again pushing the switch, the power LED ⑩ can be extinguished, permitting the input fed to the rear-mounted input connector or jack ⑰ to be delivered to the output connector or jack ⑯ as it is.

⑫ Tampering protection cover

Prevents accidental move of switch or control that has been set. Always fit the cover in place except when it needs to be removed for adjustment.

Rear Panel

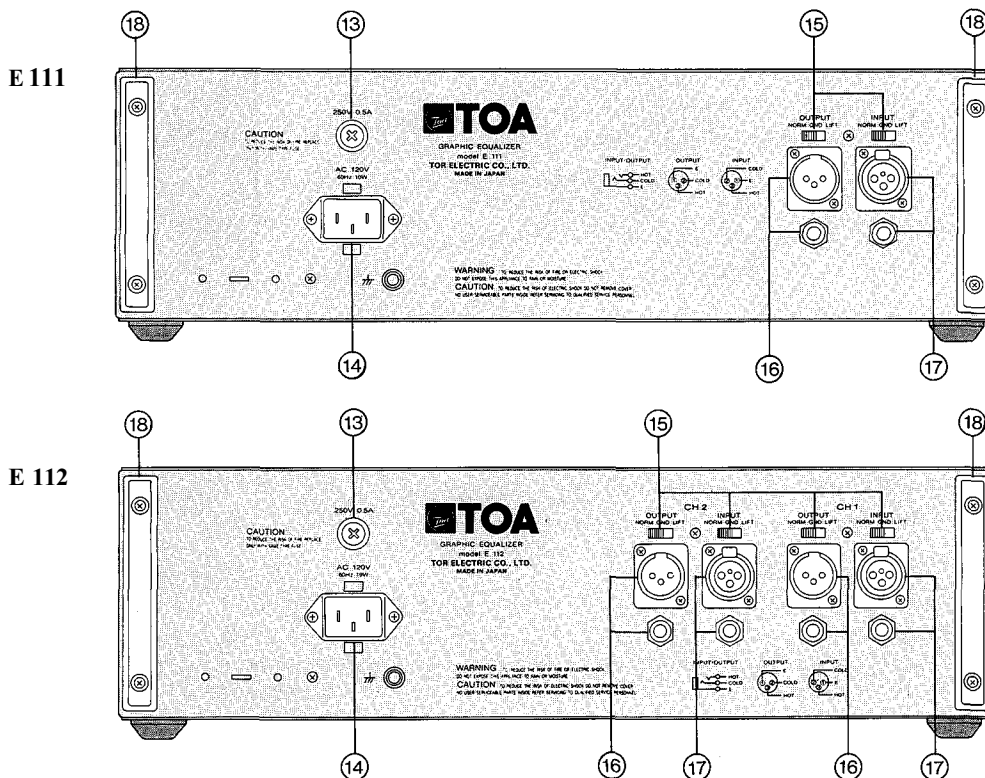

⑬ Fuse

Be sure to use the fuse of same type and capacity as are instructed.

⑭ Power inlet

An accessory power cord connects here. A use of the U-shaped clamp supplied with the equalizer by inserting it into the holes provided above and below the power inlet is recommended to prevent accidental disconnection of the power cord.

⑮ Ground lift switch

The switch is used to avoid earth loop that causes hum noise when the equalizer (E 111/E 112) is connected to other equipment. By shifting the switch to the LIFT position, the earth loop may be cut. Normally, set the switch to NORM.

⑯ Output connector and phone jack

A balanced type connector and jack with output impedance of 600 ohms. Both are wired in parallel.

⑰ Input connector and phone jack

A balanced type connector and phone jack with input impedance of 10k ohms. Both are wired in parallel.

⑱ Power cord hangers

Wind the power cord onto the hangers when the equalizer (E 111/E 112) is not in use.

Input/Output Connections

Mixing Console (RX-7)

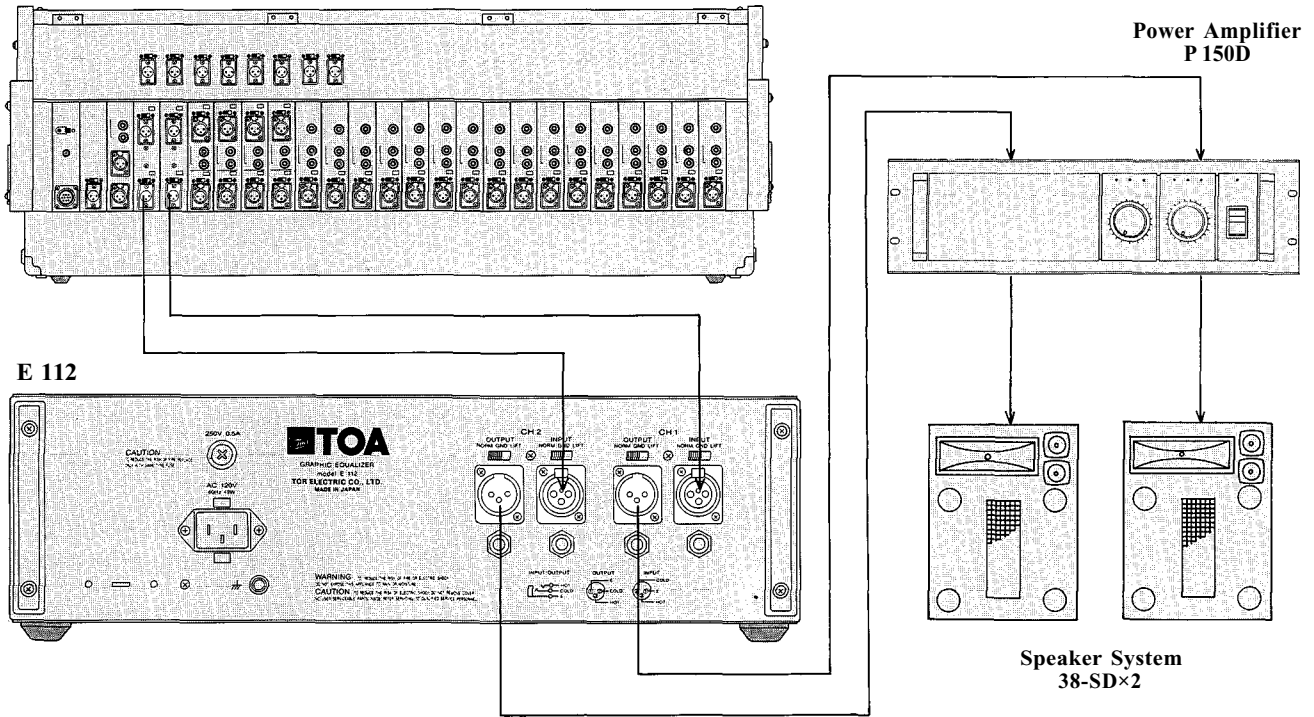

Installation Precautions

Ground Loops

In any audio system, there are numerous ways by which ground loops can be created. For example, they may occur when the E 111/112 are mounted in a rack cabinet, or through AC ground when the E 111/112 are connected with preamps, mixers, etc. These ground loops may cause hum and noise if care is not taken during connection. An increase in noise from ground loops may be minimized by breaking the ground loop. Generally, the chassis ground of the signal line should be broken as shown below.

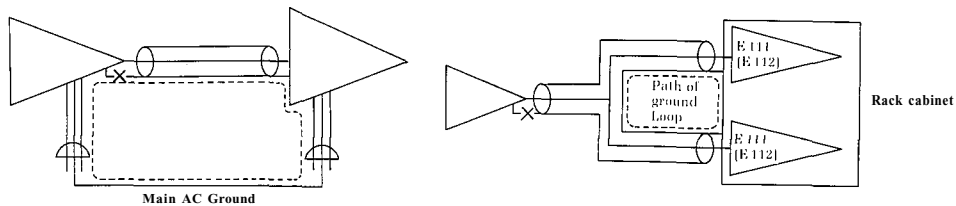

When a Y cord is used, shorten the wiring to minimize noise.

Ground lift switches are provided on the rear of the E 111/112. Sliding the ground lift switch from a NORM position to the LIFT position lifts ground.

Installation Precaution

On the road use

The E 111/112 are sturdily constructed with an aluminum die-cast front panel that is reinforced by means of an iron plate attached to its back. To ensure that strength is maintained during their transportation from one place to another, however, you should also reinforce each unit from the back of the rack with a special support bracket. This can be accomplished by removing cord-hangers on the rear panel, and screws that hold the rear panel to chassis, and fitting the special support brackets through the holes.

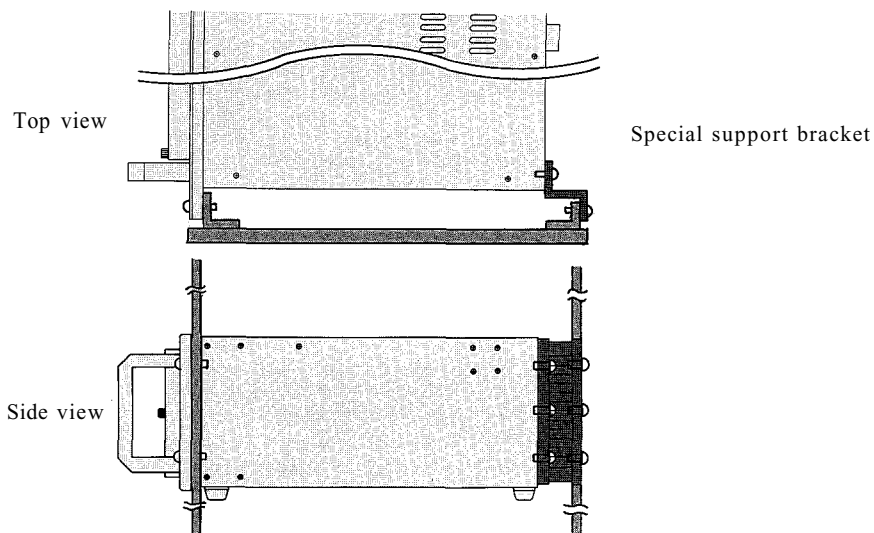

Functions

Center Frequency Control

The Center Frequency (f_c) of each frequency band is continuously variable within a range of one octave (between $0.7f_c$ and $1.4f_c$). Thus the overall frequency response may be delicately adjusted. For example, if the 1kHz center frequency control has a 12dB boost, the frequency response looks like that of curve 1. If the center frequency control is turned anticlockwise, the response will be like curve 2, while in the case of it being turned fully clockwise, the frequency response will be as shown by curve 3.

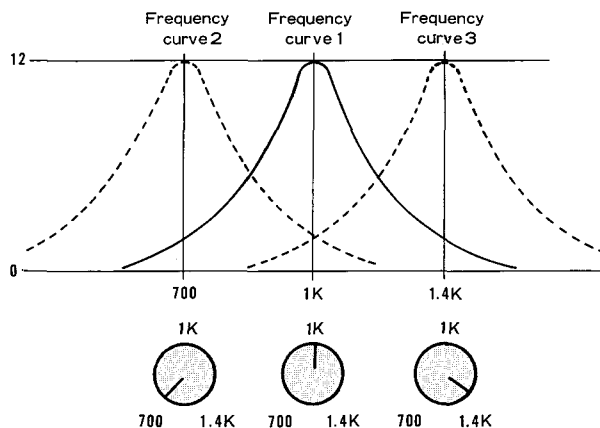

Bandwidth Control

The "Q" of each filter is continuously variable from 1.5 to 8. If the bandwidth control is turned clockwise, the bandwidth is adjusted to approximately a one octave range, while in the case of it being turned fully anticlockwise, the bandwidth is adjusted to approximately a 1/6 octave range as shown in the right figure.

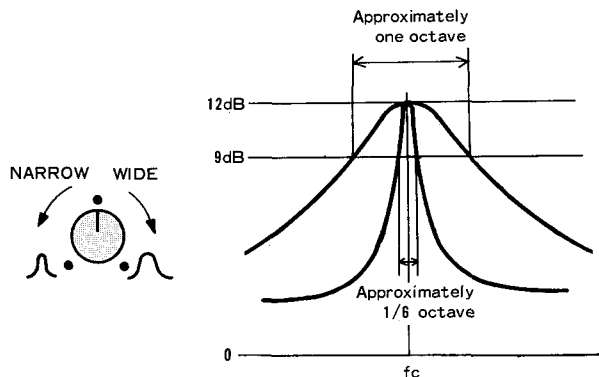

Applications

Feedback Prevention

When the overall gain of a sound system is increased, feedback will occur at frequencies where the system response has peaks. Suppose the system has an uneven frequency response like that shown in the following diagram. The frequency at which feedback will occur when gain is increased is about 500Hz. In this case, feedback may be prevented by attenuating levels at 500Hz by 5dB to 7dB with the E 111/112. If the overall gain is again gradually increased, feedback will occur next at about 125Hz. It may be stopped by attenuating the levels 2dB to 3dB at that frequency. In this procedure, sufficient gain in the sound system is obtained before feedback. When the equalizer is used for this purpose, the bandwidth controls are turned anticlockwise to prevent affecting other frequencies not needed for equalizing. In addition, the frequencies at which feedback will occur are not necessarily the same for each system and environment, therefore the equalizer is more effective if the center frequency control is made use of to precisely match center frequencies with the frequencies at which feedback occurs.

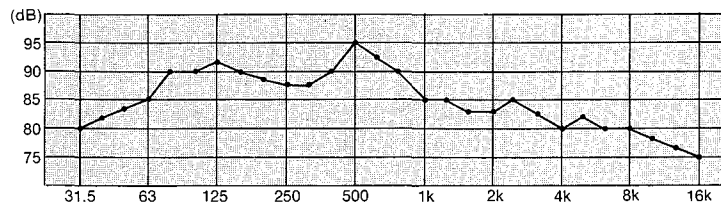

Room Equalization

In a sound reinforcement system for a room, the clarity of sound can be adversely affected by the room frequency response including standing waves (room resonances), reflections of sound, and relations between direct and indirect sound.

The E 111/112 are effective tools to equalize the room frequency response to a flat response and improve sound clarity.

The effective use of the equalizer sliders, center frequency controls, and bandwidth controls make it easy to equalize various frequency responses in rooms to be flat.

For example, suppose that there is a room frequency response as shown below.

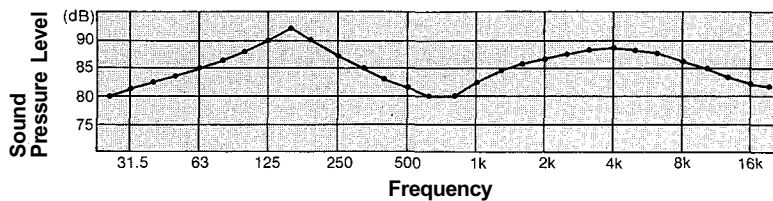

The equalizer sliders, center frequency controls and bandwidth controls are set as shown below.

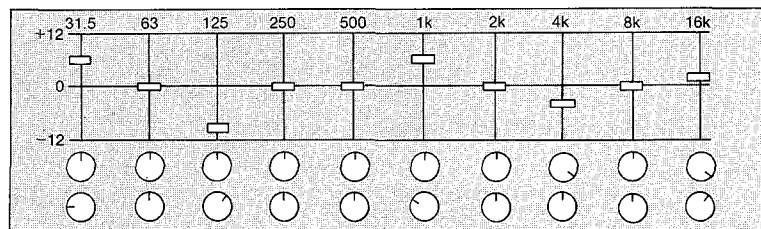

The response of those frequencies at which the corresponding equalizer sliders are set to 0dB positions will remain unchanged regardless of the positions of the center frequency controls and bandwidth controls. The overall response after equalization will then be as follows.

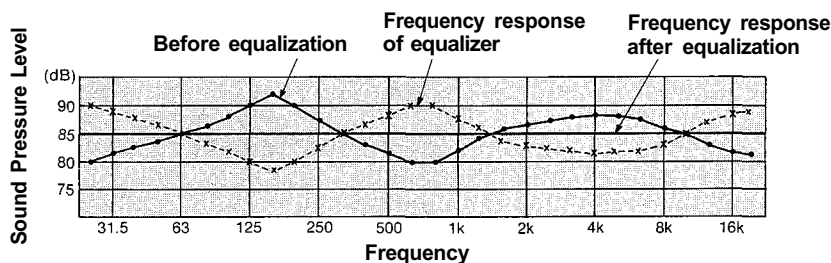

Applications

Equalization for music

The Graphic Equalizer is designed not only for use in preventing feedback and equalizing uneven room frequency response to be flat, but also for equalizing frequency response to your tastes and producing favourable sound for you. Fig. 1 shows each frequency band and its corresponding auditory feeling. Fig. 2 and Table 1 show the relation between each musical instrument and its frequency band. They can be of great help in the equalizer operation. (They are referenced from a book entitled "Practical Guide for concert")

EQUALIZATION CHART

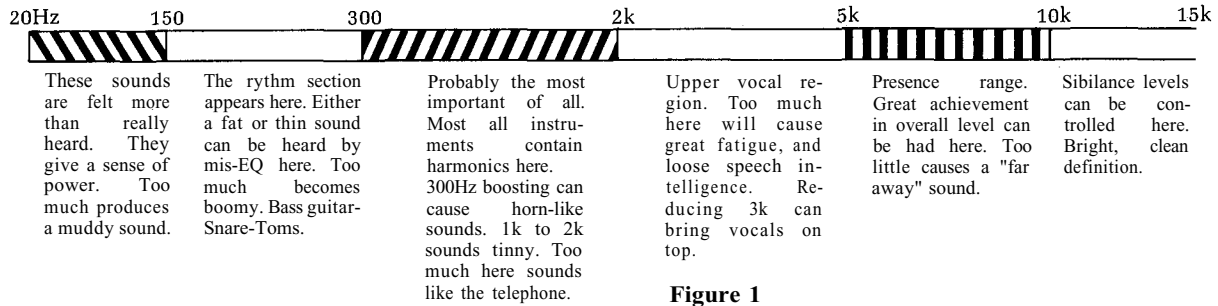

Figure 1

INSTRUMENT CHART

E 111/112 EQ. CONTROL

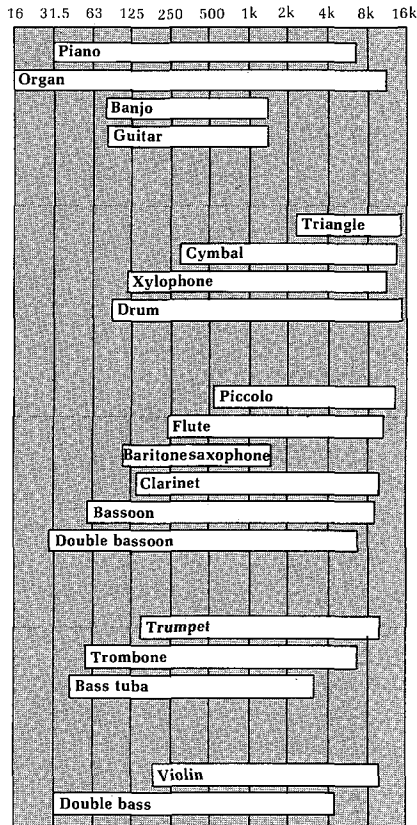
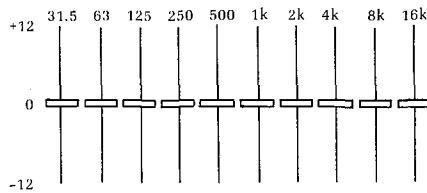

Figure 2

INSTRUMENT EQUALIZATION CHART

- Acoustic guitar** Bass strings resonate between 70 to 120Hz, body around 300Hz. Avoid boosting these to stop feedback. 3kHz and 5kHz gives great "clarity".
- Electric guitar** Resonances differ — depending on type. Good full sounds around 300 to 500Hz. Clarity at 3kHz.
- Bass guitar** Extreme lows are at 60 to 90Hz. "Pick" or "pluck" sounds are around 800 to 1200Hz. Upper harmonics clarified about 3kHz.
- Human voice** Good fullness at 150Hz. Watch for "boominess" around 250Hz. Mid-range 10kHz.
- Piano (Acoustic)** Bass strings resonate around 100Hz. Watch for sub-harmonics at 30 to 50Hz.
- Piano (Electric)** Good mid-clarity at 3kHz to 5kHz thins out rapidly in high end. Be careful around 1.5kHz to 2.5kHz to avoid the "bar room sound".
- Organ** Usually dies under 200Hz. Has great mid-sounds around 1200 to 2000Hz. Top end cuts off at 6kHz.
- Violin** Richfullness at 400Hz. Natural mids around 1500 to 2500Hz. Avoid "scratch" sounds at 8kHz.
- Brass instruments** Watch for "hot" mids around 2kHz. Low end boost around 400Hz. Top end clarity at 6kHz.
- Bass drum** Great low "kick" at 40Hz. The mids at 2kHz gives the familiar "punch".
- Snare drum** Good fullness at 100Hz. The "crack" is boosted at 2kHz. real easy. The snares extend to above 4kHz.
- Tom Tom** The main fullness is around 200Hz. The mid punch extends to 4kHz.
- Floor Tom** Same as tom, but extends down to 80Hz.
- Hi Hat** Watch for the "gong" sound around 300Hz. Good "shimmer" sounds are around 8kHz to 10kHz.
- Cymbal overhead** About the same as hi-hat only has more low end around 150Hz.
- Talk Box** Depending on the guitar sound driving it and the resonance of each player's mouth, should have great "bite" around 1200Hz and dies above 6kHz.

Table 1



TOA ELECTRIC CO, LTD.
KOBE, JAPAN